

# QUANTEM™

**USER MANUAL** QuantEM:512SC

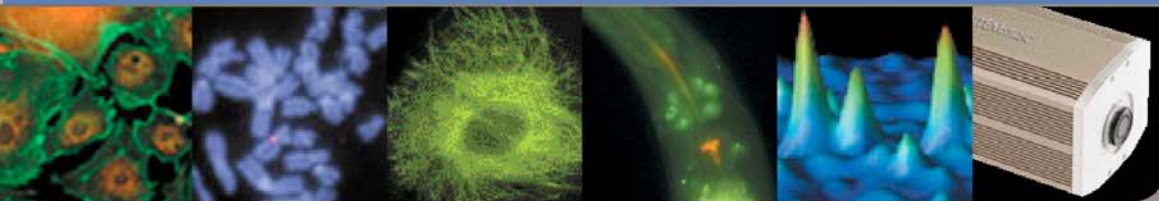

---

# User Manual for QuantEM:512SC

---



© Copyright 2006  
Photometrics  
3440 East Britannia Drive  
Tucson, Arizona 85706  
Tel: 800.874.9789/520.889.9933  
Fax: 520.295.0299

All rights reserved. No part of this publication may be reproduced by any means without the written permission of Photometrics, a division of Roper Scientific, Inc.

Printed in the United States of America.

Acrobat and Reader are registered trademarks of Adobe Systems Incorporated in the United States and/or other countries. Pentium is a registered trademark of Intel Corporation.

PVCAM, Saguro, and Photometrics are registered trademarks of Roper Scientific, Inc.

Mac, Macintosh and FireWire are trademarks of Apple Computer, Inc., registered in the U.S. and other countries.

Windows and Windows XP are registered trademarks of Microsoft Corporation in the United States and/or other countries.

Other brand and product names are the trademarks or registered trademarks of their respective owners and manufacturers.

The information in this publication is believed to be accurate as of the publication release date. However, Photometrics does not assume any responsibility for any consequences including any damages resulting from the use thereof. The information contained herein is subject to change without notice. Revision of this publication may be issued to incorporate such change.

## Customer Service

If you have any questions about your camera system, please contact Photometrics Customer Service. When you call, please have your Photometrics part number or equipment serial numbers available.

### **USA**

Photometrics  
3440 East Britannia Drive  
Tucson, Arizona 85706  
tel: 800.874.9789 or  
520.889.9933  
fax: 520.295.0299  
email: [cservice@photomet.com](mailto:cservice@photomet.com)

### **GERMANY**

Roper Scientific, GmbH  
Rosenheimer Landstr. 87  
D-85521 Ottobrunn, Germany  
tel: 49.89.660.779.3  
fax: 49.89.660.779.50  
email: [support@roperscientific.de](mailto:support@roperscientific.de)

### **BENELUX**

Roper Scientific, BV  
Ir. D.S. Tuijnmanweg 10  
4131 PN VIANEN, Netherlands  
tel: 31.347.324989  
fax: 31.347.324979  
email: [mailto@roperscientific.com](mailto:mailto@roperscientific.com)

### **JAPAN**

Nipon Roper, K.K.  
D-10E 1-3 Nakase,  
Mihama-ku, Chiba-shi  
Japan 261-8501  
tel: 81.43.274.8022  
fax: 81.43.274.8023  
email: [sales@roper.co.jp](mailto:sales@roper.co.jp)

### **FRANCE**

Roper Scientific, SARL  
Z.I. Petite Montagne Sud  
4, rue de l'Oisans - C.E. 1702  
91017 Evry Cedex, France  
tel: 33.160.86.03.65  
fax: 33.160.86.07.09  
email: [princeton.instruments@wanadoo.fr](mailto:princeton.instruments@wanadoo.fr)

### **UK**

Photometrics UK Ltd.  
Beech House  
27 Little Marlow Road  
Marlow  
Buckinghamshire  
SL7 1HA  
Tel: 44 1628 890858  
Fax: 44 1628 898381  
email: [UKsupport@photomet.co.uk](mailto:UKsupport@photomet.co.uk)

## LIMITED WARRANTY

Photometrics, a division of Roper Scientific, Inc., (“Photometrics,” us,” “we,” “our”) makes the following limited warranties. These limited warranties extend to the original purchaser (“You”, “you”) only and no other purchaser or transferee. We have complete control over all warranties and may alter or terminate any or all warranties at any time we deem necessary.

### **Basic Limited One (1) Year Warranty**

Photometrics warrants this product against substantial defects in materials and / or workmanship for a period of up to one (1) year after shipment. During this period, Photometrics will repair the product or, at its sole option, repair or replace any defective part without charge to you. You must deliver the entire product to the Photometrics factory or, at our option, to a factory-authorized service center. You are responsible for the shipping costs to return the product. International customers should contact their local Photometrics authorized representative/distributor for repair information and assistance, or visit our technical support page at [www.photomet.com](http://www.photomet.com).

### **Limited One (1) Year Warranty on Refurbished or Discontinued Products**

Photometrics warrants, with the exception of the CCD imaging device (which carries NO WARRANTIES EXPRESS OR IMPLIED), this product against defects in materials or workmanship for a period of up to one (1) year after shipment. During this period, Photometrics will repair or replace, at its sole option, any defective parts, without charge to you. You must deliver the entire product to the Photometrics factory or, at our option, a factory-authorized service center. You are responsible for the shipping costs to return the product to Photometrics. International customers should contact their local Photometrics representative/distributor for repair information and assistance or visit our technical support page at [www.photomet.com](http://www.photomet.com).

### **Normal Wear Item Disclaimer**

Photometrics does not warrant certain items against defect due to normal wear and tear. These items include internal and external shutters, cables, and connectors. *These items carry no warranty, expressed or implied.*

### **Sealed Chamber Integrity Limited 24 Month Warranty**

Photometrics warrants the sealed chamber integrity of all our products for a period of twenty-four (24) months after shipment. If, at anytime within twenty-four (24) months from the date of delivery, the detector should experience a sealed chamber failure, all parts and labor needed to restore the chamber seal will be covered by us. *Open chamber products carry NO WARRANTY TO THE CCD IMAGING DEVICE, EXPRESSED OR IMPLIED.* Responsibility for shipping charges is as described above under our Basic Limited One (1) Year Warranty.

### **Vacuum Integrity Limited 24 Month Warranty**

Photometrics warrants the vacuum integrity of all our products for a period of up to twenty-four (24) months from the date of shipment. We warrant that the detector head will maintain the factory-set operating temperature without the requirement for customer pumping. Should the detector experience a Vacuum Integrity failure at anytime within twenty-four (24) months from the date of delivery all parts and labor needed to restore the vacuum integrity will be covered by us. Responsibility for shipping charges is as described above under our Basic Limited One (1) Year Warranty.

### **Software Limited Warranty**

Photometrics warrants all of our manufactured software discs to be free from substantial defects in materials and / or workmanship under normal use for a period of one (1) year from shipment. Photometrics does not warrant that the function of the software will meet your requirements or that operation will be uninterrupted or error free. You assume responsibility for selecting the software to achieve your intended results and for the use and results obtained from the software. In addition, during the one (1) year limited warranty. The original purchaser is entitled to receive free version upgrades. Version upgrades supplied free of charge will be in the form of a download from the Internet. Those customers who do not have access to the Internet may obtain the version upgrades on a CD-ROM from our factory for an incidental shipping and handling charge. *See Item 12 in the following section of this warranty ("Your Responsibility") for more information.*

### **Owner's Manual and Troubleshooting**

You should read the owner’s manual thoroughly before operating this product. In the unlikely event that you should encounter difficulty operating this product, the owner’s manual should be consulted before contacting the Photometrics technical support staff or authorized service representative for assistance. If you have consulted the owner's manual and the problem still persists, please contact the Photometrics technical support staff or our authorized service representative. *See Item 12 in the following section of this warranty ("Your Responsibility") for more information.*

## Your Responsibility

The above Limited Warranties are subject to the following terms and conditions:

1. You must retain your bill of sale (invoice) and present it upon request for service and repairs or provide other proof of purchase satisfactory to Photometrics.
2. You must notify the Photometrics factory service center within (30) days after you have taken delivery of a product or part that you believe to be defective. With the exception of customers who claim a “technical issue” with the operation of the product or part, all invoices must be paid in full in accordance with the terms of sale. Failure to pay invoices when due may result in the interruption and/or cancellation of your one (1) year limited warranty and/or any other warranty, expressed or implied.
3. All warranty service must be made by the Photometrics factory or, at our option, an authorized service center.
4. Before products or parts can be returned for service you must contact the Photometrics factory and receive a return authorization number (RMA). Products or parts returned for service without a return authorization evidenced by an RMA will be sent back freight collect.
5. These warranties are effective only if purchased from the Photometrics factory or one of our authorized manufacturer's representatives or distributors.
6. Unless specified in the original purchase agreement, Photometrics is not responsible for installation, setup, or disassembly at the customer's location.
7. Warranties extend only to defects in materials or workmanship as limited above and do not extend to any product or part which has:
  - been lost or discarded by you;
  - been damaged as a result of misuse, improper installation, faulty or inadequate maintenance or failure to follow instructions furnished by us;
  - had serial numbers removed, altered, defaced, or rendered illegible;
  - been subjected to improper or unauthorized repair; or
  - been damaged due to fire, flood, radiation, or other “acts of God” or other contingencies beyond the control of Photometrics.
8. After the warranty period has expired, you may contact the Photometrics factory or a Photometrics-authorized representative for repair information and/or extended warranty plans.
9. Physically damaged units or units that have been modified are not acceptable for repair in or out of warranty and will be returned as received.
10. All warranties implied by state law or non-U.S. laws, including the implied warranties of merchantability and fitness for a particular purpose, are expressly limited to the duration of the limited warranties set forth above. With the exception of any warranties implied by state law or non-U.S. laws, as hereby limited, the forgoing warranty is exclusive and in lieu of all other warranties, guarantees, agreements, and similar obligations of manufacturer or seller with respect to the repair or replacement of any parts. In no event shall Photometrics' liability exceed the cost of the repair or replacement of the defective product or part.
11. This limited warranty gives you specific legal rights and you may also have other rights that may vary from state to state and from country to country. Some states and countries do not allow limitations on how long an implied warranty lasts, when an action may be brought, or the exclusion or limitation of incidental or consequential damages, so the above provisions may not apply to you.
12. When contacting us for technical support or service assistance, please refer to the Photometrics factory of purchase, contact your authorized Photometrics representative or reseller, or visit our technical support page at [www.photomet.com](http://www.photomet.com).

**C E R T I F I C A T E**  
of Conformity

**EC Council Directive 89/336/EEC**  
**as last amended by EC Directive 93/68/EEC**  
**Electromagnetic Compatibility**



**Registration No.:** AE 72062209 0001

**Report No.:** 30662241 001

**Holder:** Photometrics  
3440 East Britannia Drive  
Tucson AZ 85706  
USA

**Product:** Fotogerät  
Scientific Digital Camera

**Identification:** Model Number: QuantEM 512SC; Nikon DQC-FW  
Serial Number: Engineering Prototype 2

**Tested acc. to:** EN 61326:1997+A1+A2+A3  
FCC Part 15 Subpart B:2005  
EN 61000-3-2:2000  
EN 61000-3-3:1995+A1

This certificate of conformity is based on an evaluation of a sample of the above mentioned product. Technical Report and documentation are at the Licence Holder's disposal. This is to certify that the tested sample is in conformity with all provisions of Annex III of Council Directive 89/336/EEC, in its latest amended version, referred to as the EMC Directive. This certificate does not imply assessment of the production of the product and does not permit the use of a TÜV Rheinland mark of conformity. The holder of the certificate is authorized to use this certificate in connection with the EC declaration of conformity according to Article 10.1 of the Directive.

Certification Body

Cologne, 30.10.2006

A handwritten signature in blue ink, appearing to read 'M. Heinze'.  
Dipl.-Ing. M. Heinze

TÜV Rheinland Product Safety GmbH - Am Grauen Stein - D-51105 Köln

CE The CE marking may only be used if all relevant and effective EC Directives are complied with. CE

# Table of Contents

## Chapter 1 Overview

Introduction .....	1
Technology Introduction .....	1
System Components .....	2
About This Manual .....	3
Precautions.....	3
Environmental Requirements .....	4
Storage Requirements.....	4
Microscopes, Lenses, and Tripods.....	4
Repairs.....	4
Cleaning .....	4

## Chapter 2 System Installation

Introduction .....	5
Software Compatibility Requirements.....	5
Host Computer Requirements .....	6
Multiple Cameras.....	6
Software Installation.....	6
Installing the FireWire Interface Card.....	7
Connecting Your QuantEM:512SC Camera .....	7
To connect your QuantEM:512SC camera .....	7
Adjusting the C Mount Adapter .....	8
Travel Distance.....	9

## Chapter 3 Operating Features

Introduction .....	10
On-Chip Multiplication Gain.....	10
Offset (bias) .....	10
Exposure- Readout Modes.....	10
Non-Overlap Mode .....	11
Example: Non-Overlap Mode.....	12
Overlap Mode (Simultaneous Exposure-Readout) .....	13
Triggered Operation.....	15
Trigger-first Mode .....	15
Strobe Mode .....	16
Bulb Mode .....	16
Conversion Gain .....	17
Readout Speed (Typical) .....	17
Binning .....	17
QuantEM:512SC Features .....	18
Dual-Readout Port Operation .....	19
Conversion Gain .....	20
Readout Speed (typical).....	20
Binning .....	21
QuantEM:512SC Application Examples .....	21
Summary.....	22

## Chapter 4 Troubleshooting

System Does Not Boot Normally .....	23
New Hardware Found Dialog Box Does Not Appear (Windows 2000/XP).....	23
Images Not Displayed.....	24
Camera Running Too Warm.....	24
PVCAM Error Message Appears.....	24
Lengthy Pauses During Imaging.....	24
QuantEM:512SC Will Not Image When Attached to Certain Dual-processor or Hyperthreading-capable PCs .....	24

## Chapter 5 Basic Specifications

QuantEM:512SC Camera & Focal Plane Dimensions .....	25
CCD Specifications and Orientation .....	26
Connectors .....	28
Power Connector Pinout .....	28
I/O Connector Pinout.....	29
Power Supply Specifications and Dimensions.....	30

<b>Index.....</b>	<b>31</b>
-------------------	-----------

### Figures

Figure 1. Comparison of Traditional CCD and QuantEM CCD Array Structures.....	2
Figure 2. QuantEM:512SC Camera (with Test Lens) and DATA Cable.....	2
Figure 3. FireWire interface Card.....	3
Figure 4. DATA Cable.....	7
Figure 5. QuantEM:512SC Rear Panel .....	8
Figure 6. Adjustable C-Mount Adapter.....	8
Figure 7. Non-overlap Mode Operational Sequence .....	11
Figure 8. Required Settings for Non-Overlap Mode Operation .....	12
Figure 9. Timing Diagram for Non-Overlap Mode .....	12
Figure 10. Required Settings for Overlap Mode Operation.....	13
Figure 11. Timing Diagram for Overlap Mode when Exposure Time < Readout Time .....	14
Figure 12. Timing Diagram for Overlap Mode when Exposure Time > Readout Time .....	14
Figure 13. Trigger-First Mode Timing Diagram: Overlap Mode.....	15
Figure 14. Trigger-First Mode Timing Diagram: Non-Overlap Mode.....	15
Figure 15. Strobe Mode Timing Diagram.....	16
Figure 16. Bulb Mode Timing Diagram.....	16
Figure 17. DAC Setting vs. Charge Multiplication Gain for QuantEM:512SC.....	18
Figure 18. QuantEM:512SC CCD Array Structure.....	19
Figure 19. Software Selection of Readout Port .....	19
Figure 20. QuantEM:512SC Focal Length .....	25
Figure 21. QuantEM:512SC Front View .....	26
Figure 22. QuantEM:512SC Bottom View .....	26
Figure 23. QuantEM:512SC CCD Orientation .....	27
Figure 24. QuantEM:512SC Rear Panel .....	28
Figure 25. Power Connector Pinout.....	28
Figure 26. Input/Output Connector .....	29
Figure 27. Power Supply Front/Side & Top Views.....	30

## Tables

Table 1.	QuantEM:512SC Readout Speeds and Typical Conversion Gains.....	20
Table 2.	Application Type and QuantEM:512SC Setup Parameters.....	22
Table 3.	CCD Specifications .....	27
Table 4.	Input/Output Definitions.....	29

# Chapter 1

## Overview

### Introduction

The Photometrics® QuantEM™ camera employs an advanced CCD technology called "impact ionization" to achieve charge multiplication gain above the read noise. As a result, the cameras offer unparalleled sensitivity even at high frame rates.

QuantEM cameras are most suited for high speed and/or low-light level imaging applications such as single molecule fluorescence, ion imaging, and adaptive optics. With the traditional readout amplifier, the QuantEM can also be used for standard fluorescence and imaging applications requiring higher dynamic range.

Currently the QuantEM line consists of the following camera model:

- QuantEM:512SC
  - Uses a 512x512 Back-illuminated CCD with 16x16  $\mu\text{m}$  pixels.
  - Has two readout amplifiers – one that offers charge multiplication gain and another for traditional readout.

### Technology Introduction

The principal difference between a charge-multiplying CCD and a traditional CCD is the presence of an extended serial register in the new device (see Figure 1). Electrons are accelerated from pixel to pixel in the extended portion of the serial register (also referred to as a multiplication register) by applying higher-than-typical CCD clock voltages. This causes secondary electrons to be generated in the silicon by impact ionization. The degree of multiplication gain is controlled by increasing or decreasing clock voltages for this register (gain is exponentially proportional to the voltage). Although the probability of generating secondary electrons is fairly low (typically 0.01 per stage), over the large number of stages of a typical multiplication register, the total gain can be quite high.

This technology combines the ease of use and robustness of a traditional CCD with the gain capabilities of an intensified CCD in a single device. The combination of this technology with frame-transfer readout makes the QuantEM cameras excellent choices for experiments where fast framing and low light sensitivity are required.

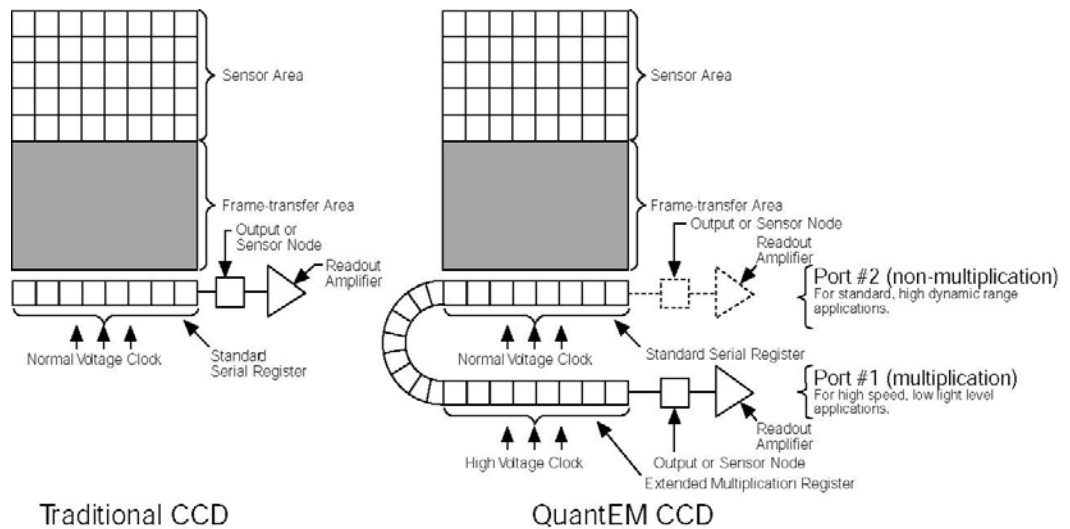

**Figure 1. Comparison of Traditional CCD and QuantEM CCD Array Structures**

The QuantEM:512SC also offers a non-multiplication readout similar to the one available in traditional CCD cameras. This makes these more versatile cameras that can be used for standard imaging applications requiring higher dynamic range.

## System Components

In addition to the components shown below and on the next page, the QuantEM:512SC package also includes PVCAM<sup>®</sup> drivers and Saguaro<sup>™</sup> imaging software.



**Figure 2. QuantEM:512SC Camera (with Test Lens) and DATA Cable**



**Figure 3. FireWire interface Card**

## About This Manual

The QuantEM:512SC User Manual is divided into five chapters. It is suggested that you read the entire manual before operating the camera in order to ensure proper use. The chapter contents are briefly described below.

---

**Note: The information in these chapters applies only to the QuantEM:512SC and is currently not applicable to any other Photometric camera.**

---

- Overview – This is a basic overview of the QuantEM:512SC that includes precautions and general maintenance/equipment information.
- System Installation – Instructions for connecting your QuantEM:512SC camera to your computer via the QuantEM FireWire interface card.
- Operating Features – Discusses QuantEM:512SC features such as on-chip multiplication gain, readout, and trigger modes. Provides additional information on dual-readout mode feature available.
- Troubleshooting – Provides answers to camera system problems.
- Basic Specifications – Provides specifications for QuantEM:512SC system components.

## Precautions

The CCD and other system electronics are extremely sensitive to electrostatic discharge (ESD). To avoid permanently damaging the system, please observe the following precautions:

- If you are using high-voltage equipment (such as an arc lamp) with your camera system, be sure to turn the camera power on last and power the camera off first.
- Never connect or disconnect any cable while the system is powered on.
- Although you should switch off the camera's power before disconnecting any camera system cable, you do not need to power off your computer to detach the cables.

- Use caution when triggering high-current switching devices (such as an arc lamp) near your system. The CCD can be permanently damaged by transient voltage spikes. If electrically noisy devices are present, an isolated, conditioned power line or dedicated isolation transformer is highly recommended.
- Always leave one inch of space around the camera's external cooling fins for airflow.
- Never open the camera. There are no user-serviceable parts inside the QuantEM:512SC camera. Opening the camera voids the warranty.
- Use only the FireWire interface card, cables, and power supply designated for this camera system. Using non-QuantEM cables, FireWire interface cards, or power supplies may result in permanent damage to your system.
- Do not use a C-mount lens with optics that extend behind the lens flange.

## Environmental Requirements

The QuantEM:512SC camera system should be operated in a clean, dry environment. The camera system's ambient operating temperature is 0°C to 30°C with 80% relative humidity, non-condensing.

## Storage Requirements

Store the QuantEM:512SC camera system in its original containers. To protect the system from excessive heat, cold, and moisture, store at an ambient temperature between -20°C and 60°C with a relative humidity of 0% to 90%, noncondensing.

## Microscopes, Lenses, and Tripods

The camera has a standard threaded video mount and can be mounted to any microscope that accepts a standard C-mount adapter. The camera also allows you to install any lens that is compatible with a standard threaded video mount as long as its optics do not extend behind the flange of the lens. The QuantEM:512SC camera can be mounted to a tripod using the tripod mounting attachment located on the bottom of the camera.

The QuantEM:512SC C-mount adapter is designed so it can be screwed in or out to change the focal depth. Once the focal depth has been changed, the adapter is secured by two setscrews. See *Adjusting the C Mount Adapter* (Chapter 2) for more information.

## Repairs

The QuantEM:512SC camera system contains no user-serviceable parts. Repairs must be done by Photometrics. Should your camera system need repair, contact Photometrics Customer Service. Please save the original packing materials so you can safely ship the camera system to another location or return it for repairs if necessary.

---

**Note: Do not open the camera. Opening the QuantEM:512SC camera voids the warranty.**

---

## Cleaning

Clean exterior surfaces of the camera with a dry, lint-free cloth. To remove stains, contact Photometrics Customer Service. To clean the camera's imaging window, use only a filtered compressed-air source. Hand-held cans are not recommended, as they may spray propellant onto the window. Do not touch the window.

# Chapter 2

# System Installation

---

Carefully review the Precautions section in the previous chapter before performing any of the procedures outlined here. Again, use only a QuantEM data cable and a QuantEM FireWire interface card with your QuantEM:512SC camera. Using a different cable or interface card may result in permanent damage to your system.

---

## Introduction

Your QuantEM:512SC camera system has the following hardware components:

- Camera head
- FireWire interface card
- Data cable
- Power supply with power cord
- Red test lens
- CD-ROM
- Quick installation Guide

QuantEM:512SC system components are linked by the data cable and controlled by your host computer system. All of these hardware components should be included with your shipment. Refer to the information and figures in the System Components section (Chapter 1).

Keep all the original packing materials so you can safely ship the QuantEM:512SC system to another location or return it for service if necessary.

If you have any difficulty with any step of the instructions, call Photometrics Customer Service.

## Software Compatibility Requirements

The QuantEM:512SC package includes the PVCAM drivers and the Saguro software program designed for use with this camera.

All other imaging software must also be PVCAM-compatible. For full access to QuantEM:512SC hardware functions, the current version of PVCAM must be used.

## Host Computer Requirements

The host computer (PC) for your QuantEM:512SC camera must have the following:

- Windows® XP (SP2) operating system
- 1 GHz Pentium® 4 (or greater)
- 256 MB RAM (or greater)
- CD-ROM drive
- At least one unused traditional PCI or PCI-X card slot
- 16-bit color display (or greater)

---

**Note: The above requirements are the minimum for operating a QuantEM camera. A faster computer with larger memory (RAM) will greatly enhance the software performance during live mode operations.**

---

If you are a Mac® user, the host computer for your QuantEM:512SC camera must have the following:

- Macintosh® OS X operating system (Power PC based)
- G4/G5 computer
- 256 MB RAM (or greater)
- CD-ROM drive
- At least one unused traditional PCI or PCI-X card slot
- Video adapter that supports 24-bit color (millions of colors)

## Multiple Cameras

PVCAM supports multiple open cameras. In order to use this function, it must also be supported by your imaging software.

If your imaging software supports multiple cameras, there must be a separate interface card for each camera.

## Software Installation

An Installation Guide appropriate to your system is included as an insert with the camera system. This guide provides step-by-step instructions for installing the camera interface software and the application software for Windows-based computers. Additional instructions are included for installing a FireWire interface card in your computer and capturing images.

The Photometrics CD-ROM contains the following files.

- MacOS directory – contains required files for installing on a Macintosh computer.
- Manuals directory – contains user manuals in PDF format.
- WinOS directory – contains the files for installing on a Windows PC.
- Linux directory – (not applicable to QuantEM:512SC).

## Installing the FireWire Interface Card

You will be using a QuantEM FireWire interface card to allow the camera to communicate with your computer.

Before installing the interface card, refer to the 'Release Notes' files on the CD-ROM and to the Software Installation insert. The insert instructions will step you through the FireWire interface card installation.

After installing the interface card, continue to *Connecting Your QuantEM:512SC Camera*.

## Connecting Your QuantEM:512SC Camera

The following connectors are located on the back of the QuantEM:512SC camera:

- DATA connector: Type 1, 6-pin IEEE-1394a (FireWire) connector for data transfer
- POWER connector: 5-pin, LEMO connector for camera power (see POWER Connector Pinout section in Chapter 5 for details)
- I/O connector: Hirose HR10A-10R-10S, 10-pin connector for input/output control signals (see I/O Connector Pinout later in this manual)
- Power switch: Turns the camera on and off (|=on, O=off)

### To connect your QuantEM:512SC camera

1. Connect either end of the DATA cable to the QuantEM FireWire interface card that you have installed in the host computer. The DATA cable (shown below) connects your QuantEM:512SC camera to the QuantEM FireWire interface card. This interface cable is identifiable by its 6-pin connectors. It is designed to serve as a conduit for data.



**Figure 4. DATA Cable**

2. Connect the other end of the DATA cable to the FireWire port (indicated with blue arrow in next graphic) located on the back of the camera.



**Figure 5. QuantEM:512SC Rear Panel**

3. Verify that the power switch on the back of the camera is in the position (| =on, O=Off).
4. Connect the power supply to the Power connector on the back of the camera.
5. Plug the power cord into the power supply and then into a suitable wall outlet.
6. Switch on the camera (power switch on the back of camera).

## Adjusting the C Mount Adapter

The QuantEM:512SC features an adjustable C-mount adapter that allows you to change the focal depth. The C-mount adapter is adjusted in the factory to nominal C-mount back focal distance. Adjust the C-mount adapter only if you cannot achieve focus on your instrument.

If required, use a .050" hex key to adjust the adapter as follows:

1. Loosen the two setscrews and rotate the ring to the desired height (see next figure). The amount of travel possible depends on the camera model. Tighten the screws to lock the adapter in place, after confirming desired height.

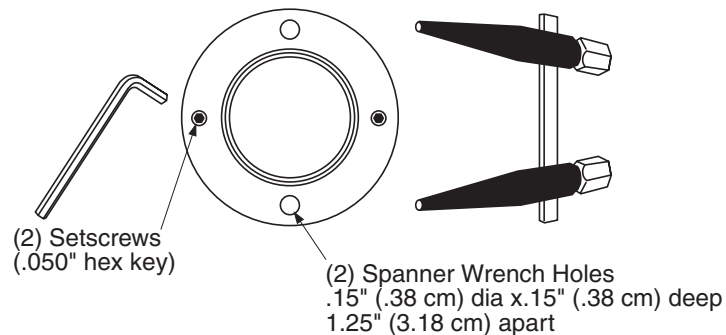

**Figure 6. Adjustable C-Mount Adapter**

## Travel Distance

QuantEM:512SC = .215" / .546cm

---

**Note:** A spanner wrench can be used to rotate the adapter after the setscrews have been loosened. The spanner holes are .15" (.38 cm) dia. x .15" (.38 cm) deep and are spaced 1.25" (3.18 cm) apart. To lock the setscrews, the travel distance must be less than .215" (.54 cm).

---

# Chapter 3

## Operating Features

### Introduction

The features described in this section are identical in all QuantEM:512SC cameras unless otherwise stated.

#### On-Chip Multiplication Gain

As explained previously, the QuantEM:512SC uses a unique CCD capable of multiplying the charge (electrons) generated in the pixels. When the multiplication is sufficiently high, it is possible to see extremely low-light events. The amount of multiplication is controlled by the voltage applied to multiplication register clocks. These are certified by a quantitative multiplication gain slider which has 0-100 steps. The calibration feature of the camera maps the gain slider to a voltage which will provide the electron multiplication level selected.

#### Offset (bias)

CCD cameras are typically designed to produce a certain level of offset (also known as bias) when no light is present and the exposure time is set to zero (0). Typically, the user subtracts an offset (bias) from the sample image for quantitative measurement. Since the offset can change based on several factors such as multiplication gain, speed, etc., it is recommended that a fresh offset (bias) image be taken with the same settings as the sample image and then be subtracted from the sample image.

The QuantEM:512SC has an automatically adjusting offset switch. When a speed/gain setting is altered, the bias valve is kept as close to a pre-selected offset as possible. This enhances the quantitative stability of the camera.

#### Exposure- Readout Modes

The QuantEM:512SC camera uses a frame transfer CCD and supports Non-Overlap and Overlap exposure and readout modes. These modes are further described in the sections that follow.

---

**Note:** A frame transfer CCD has both a light-sensitive area (sensor area) and a storage area (frame transfer area). Since the image can be quickly transferred from the sensor area to the frame transfer area, there is no need for a mechanical shutter.

---

## Non-Overlap Mode

Non-Overlap mode allows you to expose the array for the exposure time specified in the software and is similar in performance to a normal, full-frame device. The operational sequence for this mode is:

1. Clearing the CCD,
2. Exposing for the specified exposure time,
3. Shifting the image from the sensor area to the frame-transfer area, and
4. Reading out the CCD.

Steps 1-4 are repeated for each frame in a sequence. Steps 1 and 3, clearing the CCD and shifting the image, are usually very short and typically have minimum impact on the frame rate.

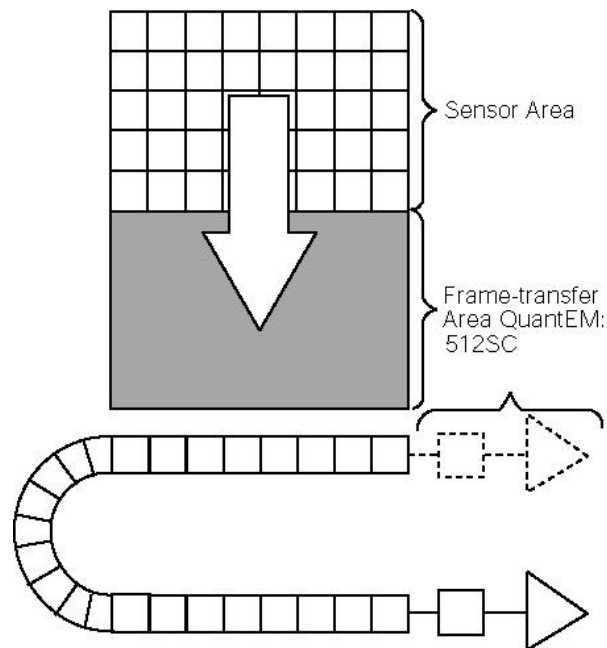

**Figure 7. Non-overlap Mode Operational Sequence**

In PVCAM compatible software, this sequence is programmed by simply setting:

- clocking mode to “Frame transfer” and
- clearing mode to “Pre-exposure” with clear count of “1” (or more).

Figure 8 shows these settings on a software dialogue box.

---

**Note: Since the software you are using may show the settings differently, you should refer to the software documentation for accurate information.**

---

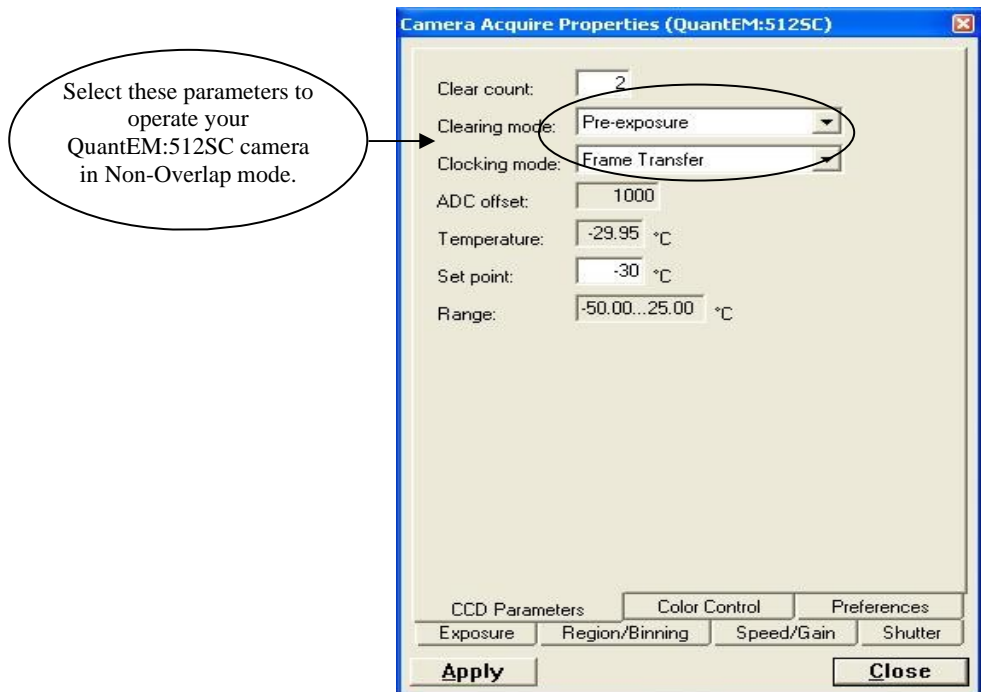

**Figure 8. Required Settings for Non-Overlap Mode Operation**

**Example:  
Non-Overlap  
Mode**

Operation in Non-Overlap mode is illustrated in the timing diagram below. In this example, the exposure time is 10 ms and the readout time is 34.8 ms. The total time to take 3 frames is 134.4 ms ( $3 \times 10 \text{ ms} + 3 \times 34.8 \text{ ms}$ ), equivalent to a frame rate of 22.3 fps ( $3 \text{ frames} \div 0.134 \text{ seconds}$ ).

---

**Note: The exposure and readout times listed are for illustration purpose only. Actual values may vary. Refer to the product data sheet for the actual readout times.**

---

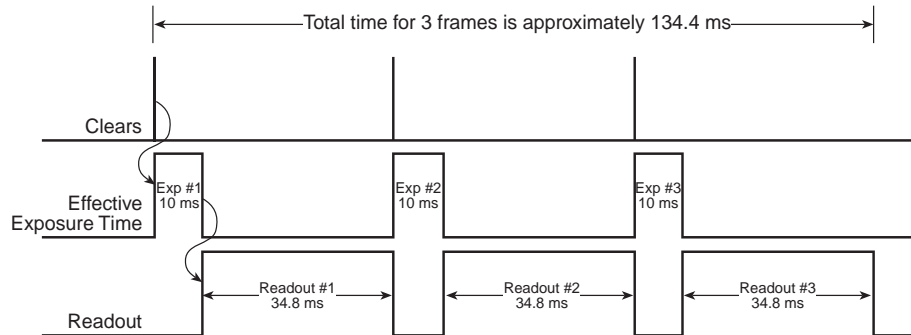

**Figure 9. Timing Diagram for Non-Overlap Mode**

Referring to Figure 9, it can be seen that exposure and readout are carried out in non-overlapped fashion. As a result, each frame in the sequence is precisely exposed for the time specified (i.e., 10 ms).

## Overlap Mode (Simultaneous Exposure-Readout)

Overlap mode is extremely useful in applications requiring continuous imaging (100% duty cycle). Once a frame is exposed and transferred into the frame transfer area, the next exposure immediately starts and continues until the previous frame is read out or until the exposure time is finished, whichever is longer (so the minimum effective exposure time in this mode is the readout time). This mode of operation allows you to continuously image a specimen to obtain better kinetic information about a process.

Figure 10 shows required QuantEM:512SC settings for overlap mode. Note that the clearing mode is set to "Pre-sequence" (as opposed to "Pre-exposure" in Non-Overlap mode).

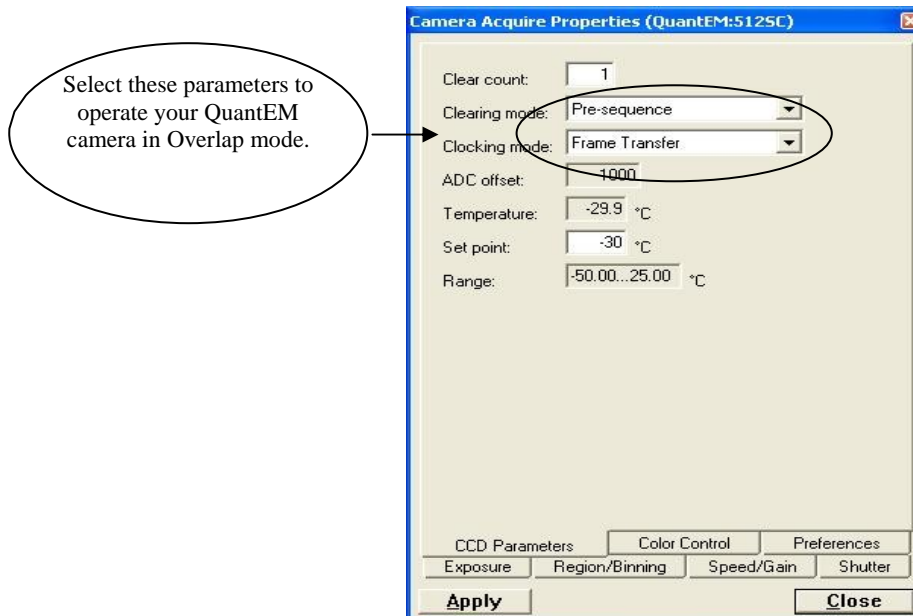

**Figure 10. Required Settings for Overlap Mode Operation**

---

**Note:** In Overlap mode, the minimum effective exposure time is the readout time.

---

The simultaneous exposure-readout mechanism is illustrated with two examples.

### **Example 1: Overlap Mode when Exposure Time < Readout Time**

Consider a situation where full frame readout is 34.8 ms, the exposure time is 10 ms, and three frames are taken in overlap mode. The first frame is exposed precisely for the length of time entered into the software (10 ms) and all subsequent frames are exposed for the readout time. The total time to acquire 3 frames is then 114.4 ms ( $3 \times 34.8 \text{ ms} + 10 \text{ ms}$ ), equivalent to a frame rate of 26.2 fps ( $3 \text{ frames} \div 0.114 \text{ seconds}$ ).

---

**Note:** Because the first frame is exposed for 10 ms and the others for 34.8 ms, the first frame may look less bright compared to all other frames.

---

In Overlap mode when exposure time < readout time, the total time ( $T_N$ ) taken to capture N frames is given by:

$$T_N = (t_R \times N) + t_{exp}$$

Where

$T_N$  = Total time taken to capture a sequence of N frames

$t_R$  = readout time for one frame

N = total number of frames in a sequence

$t_{exp}$  = exposure time

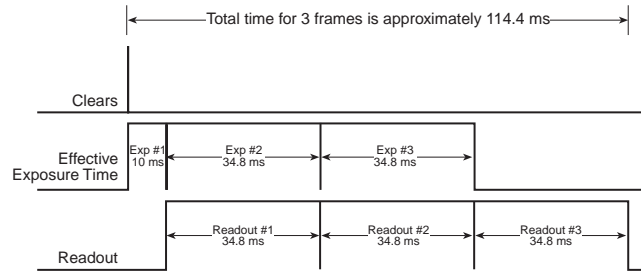

**Figure 11. Timing Diagram for Overlap Mode when Exposure Time < Readout Time**

**Example 2: Overlap Mode when Exposure Time > Readout Time**

If the exposure time is set to 50 ms with the readout time remaining at 34.8 ms, the time taken to acquire 3 frames will be 184.8 ms ( $3 \times 50 \text{ ms} + 34.8 \text{ ms}$ ), which is equivalent to a frame rate of 16.2 fps.

In Overlap mode when exposure time > readout time, the total time ( $T_N$ ) taken to capture N frames is expressed as:

$$T_N = (t_{exp} \times N) + t_R$$

Where

$T_N$  = Total time taken to capture a sequence of N frames

$t_{exp}$  = exposure time

N = total number of frames in a sequence

$t_R$  = readout time for one frame

From the timing diagram, you can see that because the exposure time is greater than the readout time, all frames are precisely exposed for the duration entered into the software and have similar intensities.

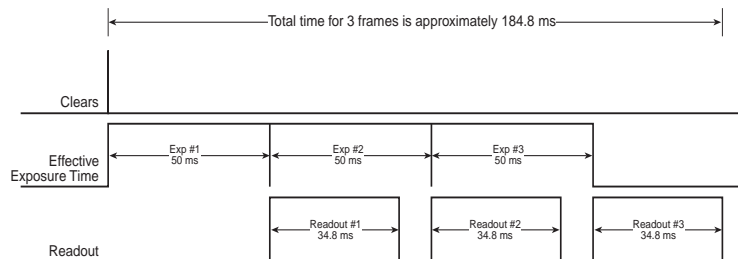

**Figure 12. Timing Diagram for Overlap Mode when Exposure Time > Readout Time**

## Triggered Operation

The QuantEM:512SC camera offers several methods of integration with external trigger sources, such as delay generators or laser pre-triggers. Each camera has a 10-pin, Hirose HR10A I/O connector (pinout functions are described in Chapter 5) on the back for trigger input/out and various TTL input and output operations. A special cable is available from Photometrics to access primary signals such as "Trigger input," "Expose out," "Frame readout," and "Shutter out." In the default mode, the camera triggers on the rising edge of a TTL signal. QuantEM:512SC camera's support the trigger modes described in the next sections.

### Trigger-first Mode

In this mode, the camera requires only one trigger to acquire a sequence of frames. The camera can operate in overlap or non-overlap mode depending on the settings explained in the previous section. Once the initial trigger is received, the camera ignores any further triggers until the entire exposure/readout sequence is completed (see Figures 13 and 14, which show a three-frame sequence).

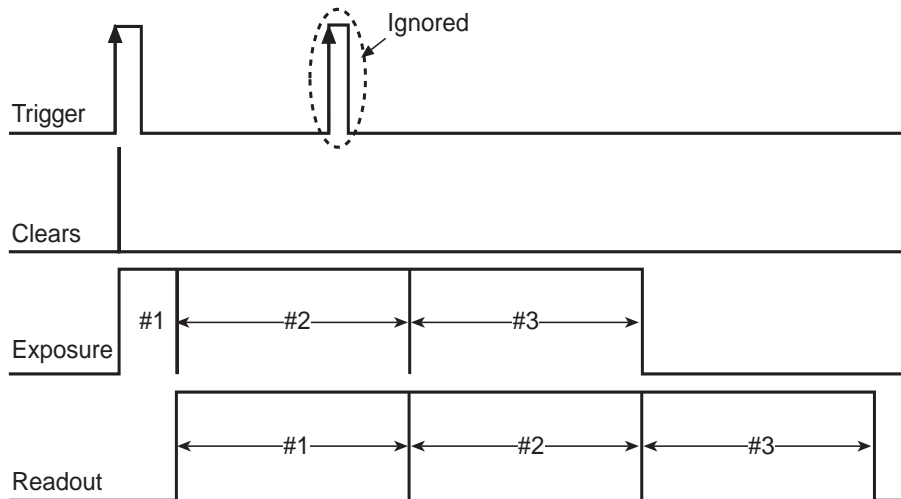

**Figure 13. Trigger-First Mode Timing Diagram: Overlap Mode**

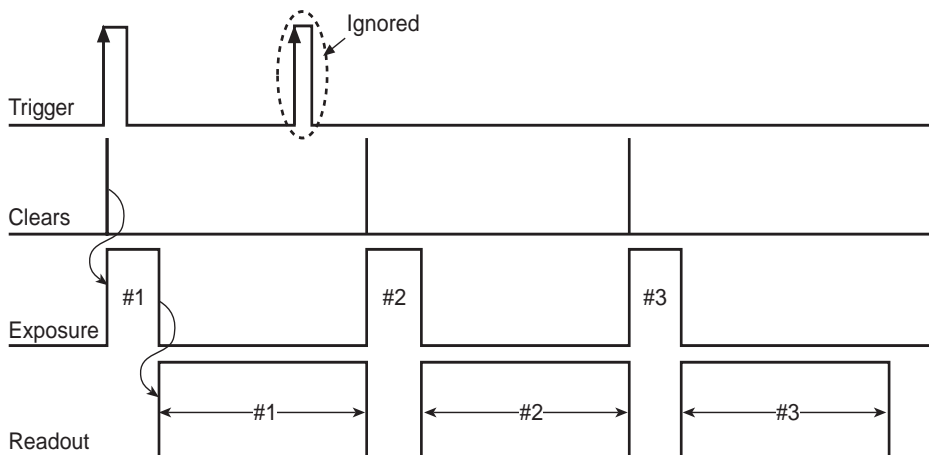

**Figure 14. Trigger-First Mode Timing Diagram: Non-Overlap Mode**

## Strobe Mode

In Strobe mode, each frame in a sequence requires a trigger. Each frame is exposed for the length of time entered into the software and is then read out. If a trigger arrives during the exposure-readout of the previous frame, it is ignored (see Figure 15). For a sequence of one frame, strobe mode and trigger-first mode are the same. The shaded areas  denote the idle time between exposures. Strobe mode only operates in Non-Overlap mode.

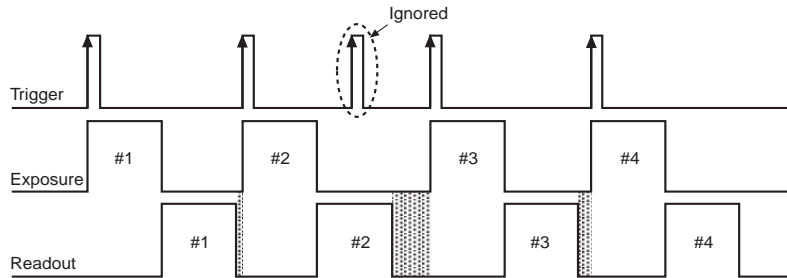

**Figure 15. Strobe Mode Timing Diagram**

## Bulb Mode

In Bulb mode, exposure time for each frame is determined by the trigger pulse width. Exposure time entered into the software is ignored in this mode (see Figure 16). If a trigger arrives during the readout of the previous frame, it is ignored. The shaded areas  denote the idle time between exposures. Bulb mode only operates in Non-Overlap mode.

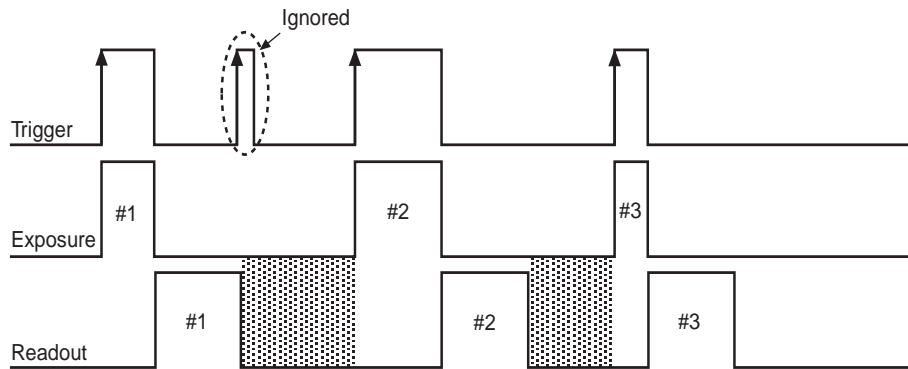

**Figure 16. Bulb Mode Timing Diagram**

---

### Notes:

1. When the clocking mode is "Alternate Frame Transfer", the camera can be operated in "Overlap" or "Non-Overlap" mode as explained previously.
  2. Trigger-first mode allows overlap or non-overlap modes. In strobe and bulb triggering modes, the camera can be operated in non-overlap mode only.
-

## Conversion Gain

Apart from multiplication gain, which actually multiplies the number of electrons generated in each pixel, the QuantEM:512SC also has three (3) conversion gains. Conversion gain simply quantifies how the resulting electrons are converted into ADU (Analog-to-Digital units) and displayed on the display screen.

Typical conversion gains for the readout port are listed later in this chapter. Your camera is individually calibrated for these gains. So, please refer to the certificate of performance that accompanied your camera.

---

**Note: As the on-chip multiplication introduces additional noise, it is recommended that the multiplication be used only as required. For more information, refer to the "On-Chip Multiplication Gain" technical note. This technical note can be accessed by going to the Photometrics web site at [www.photomet.com](http://www.photomet.com), clicking on "Library", clicking on "Technical Notes", and selecting the title from the list of notes.**

---

## Readout Speed (Typical)

QuantEM:512SC cameras are implemented with 10 MHz, 5MHz and 1.25 MHz digitization speeds (10 million, 5 million and 1.25 million pixels per second, respectively). At 10 MHz it gives approximately 31 frames per second (fps), whereas 1.25 MHz operation offers better image quality. With either digitizer, increased frame rate can be achieved by choosing a sub-region. For more information, please refer to the product data sheets.

The camera uses a frame-transfer CCD with a built-in storage (frame transfer) area, which makes simultaneous exposure and readout possible (Overlap mode) and which allows precise exposures to be set (Non-Overlap mode). These two readout modes are further explained in the "Exposure - Readout Modes" section in this chapter.

## Binning

Binning (combining pixels into one super pixel) allows you to increase the sensitivity and frame rate. On the other hand, binning reduces spatial resolution. The QuantEM:512SC allows binning of 1, 2, 4, and 8 in the serial (horizontal) direction and 1 to 256 binning in the parallel direction.

# QuantEM:512SC

## Features

The QuantEM:512SC has incorporated a calibration routine which allows the camera to adjust voltages of the ADC offsets such that the electron multiplication gain input given to the camera reflects the actual gain provided by the device. Settings 1 to 100 on the electron multiplication gain slider are mapped linearly to provide the actual multiplication gain requested by the user. Due to the impact-ionization method used with the electron-multiplication gain register the actual gain realized by the detector with time will slowly be reduced. By using the calibration routine the camera is able to re-establish the electron multiplication gain slider such that it will provide the gain which is input on the gain slider. This ensures the quantitative nature of the camera over time. Even though the camera is capable of delivering large multiplication gain factors, multiplication gain should only be used as needed to preserve as much dynamic range as necessary and to prolong the device's lifetime.

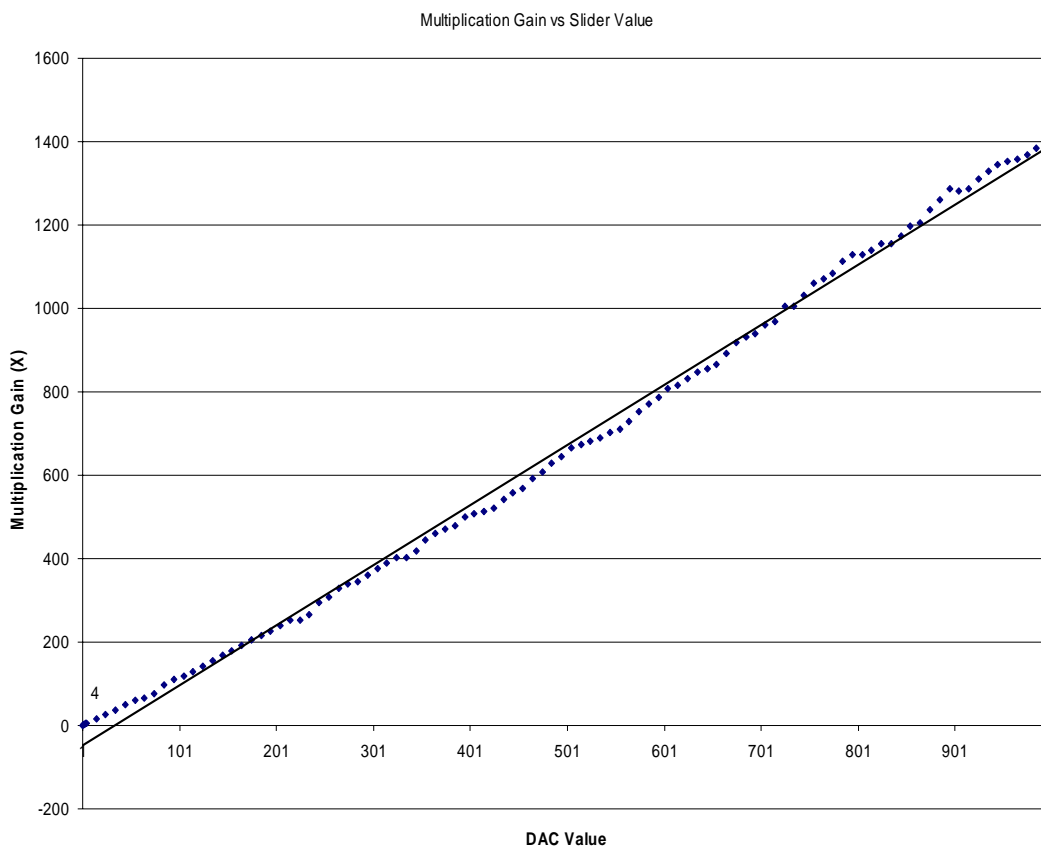

**Figure 17. DAC Setting vs. Charge Multiplication Gain for QuantEM:512SC**

## Dual-Readout Port Operation

The QuantEM:512SC is configured with software-selectable dual-readout amplifiers, also referred to as "ports", shown in the next figure. The two amplifiers are listed below.

Port #1: On-chip Multiplication amplifier

Port #2: Traditional or non-multiplication amplifier

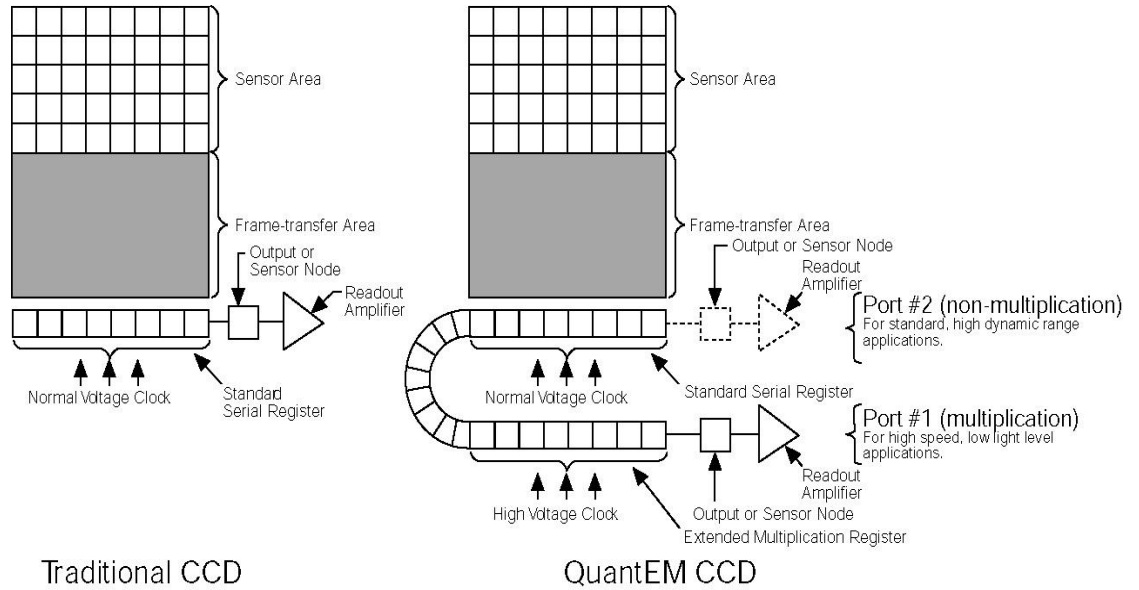

**Figure 18. QuantEM:512SC CCD Array Structure**

The software allows port selection. An example of a software dialogue to select the ports is shown in the next figure.

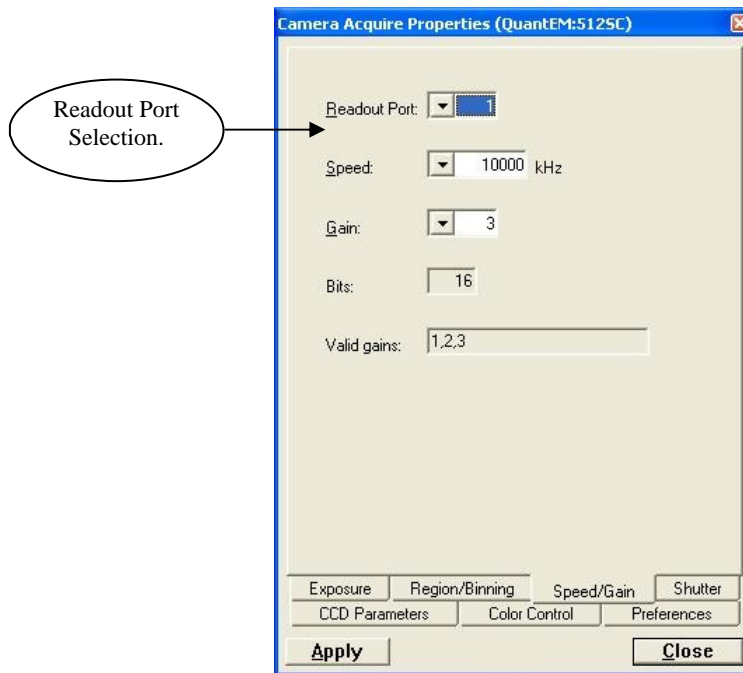

**Figure 19. Software Selection of Readout Port**

---

**Note:** As the user interface may be different, please refer to your software manual for specific information on readout amplifier/port selection.

---

**On-Chip Multiplication Amplifier (Port #1):** Operation of multiplication gain in the QuantEM:512SC is different from the previous generation of these cameras. The new "QuantEM" generation of cameras have new functionality that was not available on previous models. A setting of 0 (zero) results in unity gain and the subsequent settings are linearly related to the actual multiplication gain. Since the multiplication gain can be used to overcome the read noise of the fast amplifier, this mode is most useful in applications requiring low-light sensitivity at high frame rates (e.g., Single molecule fluorescence, ion imaging, etc.).

---

**Note:** When used with a standard lens, Port #1 (multiplication port) produces an image in the correct orientation. The first pixel is read out at the bottom left of the array.

---

**Traditional or Non-Multiplication amplifier (Port #2):** When the camera is using this amplifier, electrons (signal) generated in pixels are clocked through the standard serial register. The amplifier is designed to take advantage of the dynamic range of the CCD and is most useful when the frame rate is not critical, (e.g., bright field, fixed cell fluorescence, etc.).

---

**Note:** Since the first pixel to be read out from Port #2 is at the bottom right (closest to the Port #2), the resulting image is a mirror image of the same image if it were read out of Port #1. Some software packages do a "horizontal-flip" in the software when Port #2 is selected to ensure the correct orientation for all ports. Please check your software documentation.

---

## Conversion Gain

Apart from multiplication gain, which actually multiplies the number of electrons generated in each pixel, the QuantEM:512SC also has three (3) conversion gains. Conversion gain simply quantifies how the resulting electrons are converted into ADU (Analog-to-Digital units) and displayed on the display screen.

Typical conversion gains for different ports are listed in Table 1. Your camera is individually calibrated for these gains. So, please refer to the certificate of performance that accompanied your camera.

## Readout Speed (typical)

The QuantEM:512SC has two readout speeds available on each of the two ports as listed in the table below:

Readout Amplifier (Port)	Readout Speeds	Conversion Gain (e <sup>-</sup> /ADU)
Port #1 (Multiplication)	5 MHz 10 MHz	#1: 12e <sup>-</sup> /ADU #2: 6e <sup>-</sup> /ADU #3: 3e <sup>-</sup> /ADU
Port #2 (Non-multiplication)	1.25 MHz 5 MHz	#1: 4e <sup>-</sup> /ADU #2: 2e <sup>-</sup> /ADU #3: 1e <sup>-</sup> /ADU

**Table 1. QuantEM:512SC Readout Speeds and Typical Conversion Gains**

A slower readout speed can be used when better noise performance is needed at the expense of frame rate. On the other hand, increased frame readout rate can be achieved by one or more of the following:

- higher readout speed,
- sub-region selection,
- binning.

For more information on frame rate, please refer to the product data sheet.

## Binning

Binning (combining pixels into one super pixel) allows you to increase the sensitivity and frame rate. On the other hand, binning reduces spatial resolution. The QuantEM:512SC allows binning of 1, 2, 4 and 8 in the serial (horizontal) direction and binning in the parallel (vertical) direction, up to 256.

---

**Note: Due to the small array size in the QuantEM:512SC edge artifacts may be present at higher binning.**

---

## QuantEM:512SC Application Examples

### Example 1:

*"I would like to obtain kinetic information (time-correlated) information of the single molecule fluorescence. My light level is fairly low and I want to optimize the frame rate of the camera."*

For this application, the "Multiplication" port (Port #1) should be selected and camera speed should be set to 10 MHz. In addition, the camera should be operated in "Overlap mode". This can be achieved by setting the camera to "frame transfer mode" with clearing mode "Pre-sequence" and number of clears "1" (refer to Figure 11). If possible, choose a sub-region (ROI) and/or binning to further increase the frame rate. Finally, on-chip multiplication gain can be used to boost the signal level and achieve a high signal-to-noise ratio.

### Example 2:

*"My application requires precise control of the exposure time (less than the readout time) and I want to operate the camera in the most sensitive mode possible."*

For better imaging characteristics, the "Multiplication" port (Port #1) is selected and camera speed must be set to 5 MHz. Use on-chip multiplication gain for increased sensitivity. To achieve an exposure time less than readout time, use Non-Overlap mode (shown in Figure 9) and set the clearing mode to "Pre-exposure" and clear count to "2".

### Example 3:

*"I would like to image a bright target/sample (e.g., fluorescence or bright field) that is fixed. High resolution and high dynamic range are important."*

For imaging bright, non-moving samples, the "Non-multiplication" port (Port #2) offers the best performance in terms of dynamic range. Set the speed to 1.25 MHz (or 5 MHz, if higher speed is required) and conversion gain to #2 (this allows maximum full well of the CCD to be used). Reading out the full CCD (no-ROI or binning) gives best resolution possible. In addition, camera can be operated in overlap or non-overlap mode as explained before.

## Application Settings Summary

The table below summarizes typical QuantEM:512SC settings for two types of applications and is provided as a setup aid. Actual settings will vary based on the exact nature of your experiment design.

Application	Readout Amplifier (Port)	Readout Speed	Multiplication Gain	Conversion Gain (e-/ADU)	Readout Mode
Kinetic samples (single molecule fluorescence or tracking)	Multiplication (Port #1)	10 MHz or 5 MHz	Use as required to obtain best signal-to-noise ratio (SNR). <i>Typical EM gain values are around 200.</i>	#2: 6e <sup>-</sup> /ADU	Overlap mode (Frame Transfer, Pre-Sequence)
Fixed samples (bright field)	Non-multiplication (Port #2)	1.25 MHz	Not Applicable	#1: 4e <sup>-</sup> /ADU	Overlap or Non-overlap

**Table 2. Application Type and QuantEM:512SC Setup Parameters**

# Chapter 4

## Troubleshooting

---

If you have any difficulty while troubleshooting, or do not see your camera system's symptoms listed here, contact Photometrics Customer Service.

---

### System Does Not Boot Normally

If your operating system does not boot normally after you have installed an interface card, try installing the new card in another open PCI slot. If this does not work:

1. Turn off your computer and remove the newly installed interface card.
2. Turn your computer back on. If your system boots normally, there is probably an interrupt conflict between a previously installed expansion card and the interface card that you are installing.
3. If you need assistance resolving the interrupt conflict, contact Photometrics Customer Service.

### New Hardware Found Dialog Box Does Not Appear (Windows 2000/XP)

If the New Hardware Found dialog box does not appear after installing a new interface card to your computer and booting Windows 2000/XP:

- Check to make sure that the new interface card is inserted in an expansion slot according to your computer manufacturer's instructions and that the QuantEM:512SC system's CD-ROM disc is in the host computer's CD drive.
- It is possible that there is a conflict between the new interface card and a previously installed expansion card. With the computer's power turned off, remove any previously installed expansion cards that your system does not need to function. (If you are unsure which cards can be safely removed, call Photometrics Customer Service.) Then turn your computer back on and boot Windows 2000/XP again.
- If the New Hardware Found dialog box still does not appear, contact Photometrics Customer Service.

## Images Not Displayed

If no images appear:

- Confirm that the camera switch is set to “|”.
- Confirm that the QuantEM:512SC camera is selected in your imaging software application.
- Power off the camera and the host computer and check all system connections (particularly the DATA and power cables). Restart.
- Confirm that operating system is set for at least 64k colors (16 bits).
- Confirm that the camera is operational by taking an image with a standard C-mount lens attached to your QuantEM:512SC. Using normal room lighting, place the camera on a table about 3 meters away from an object and acquire an image.

If the problem persists, contact Photometrics Customer Service.

## Camera Running Too Warm

It is normal for the camera to be slightly warm to the touch while in operation. However, if the camera is more than slightly warm to the touch (and at least one inch of space has been left around the external cooling fins for airflow), switch off the camera immediately and contact Photometrics Customer Service.

## PVCAM Error Message Appears

If a PVCAM error message appears, note the message's number code and contact Photometrics Customer Service.

## Lengthy Pauses During Imaging

If you notice lengthy pauses marked by a lot of disk activity while imaging:

- Close any other programs that may be running.
- Install more physical memory (RAM) in your computer system.

## QuantEM:512SC Will Not Image When Attached to Certain Dual-processor or Hyperthreading-capable PCs

Some high-end Windows 2000/XP-enabled computers with Intel Pentium or Xeon™ processors include a memory enhancement called Physical Address Extension (PAE). PAE allows these computers to address memory above 4GB; however, when PAE is enabled the IEEE-1394 QuantEM:512SC camera will not transmit any pixel data.

To determine whether your computer is running with PAE enabled, go to the Control Panel and open the "System" icon. Under the "General" tab, you will find a reference to Physical Address Extension in the "Computer" section.

To disable PAE, you must edit your C:\boot.ini file and remove the /PAE flag.

# Chapter 5

## Basic Specifications

### QuantEM:512SC Camera & Focal Plane Dimensions

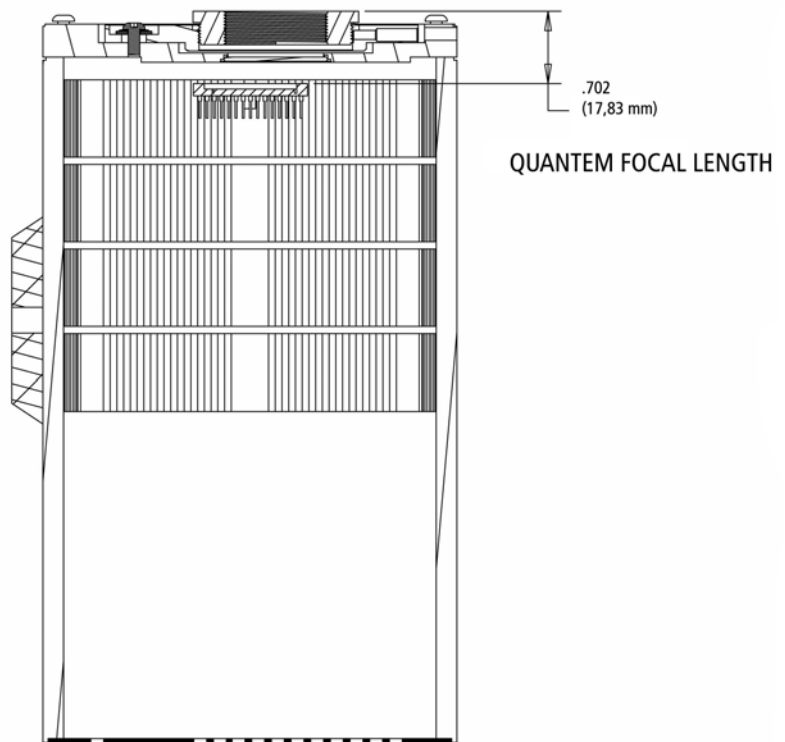

**Figure 20. QuantEM:512SC Focal Length**

**QuantEm:512SC**  
**Front/Bottom Views**

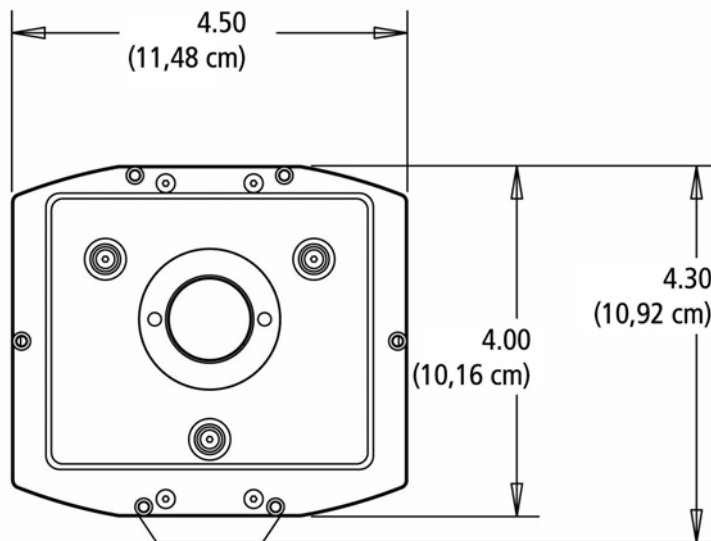

**QUANTEM FRONT VIEW**

*Figure 21. QuantEM:512SC Front View*

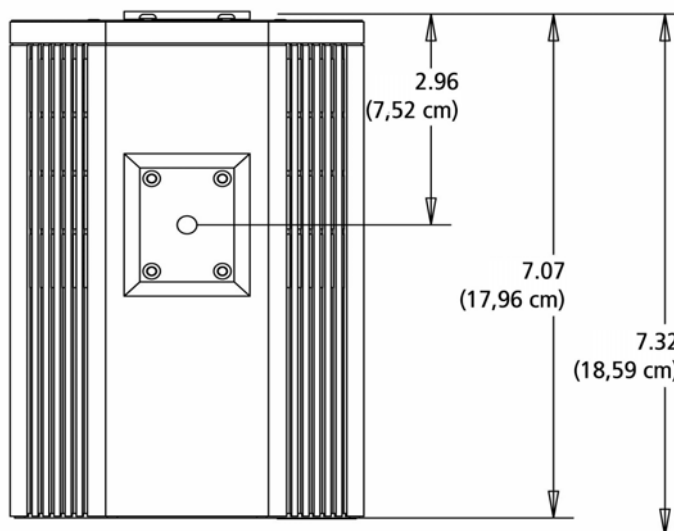

**QUANTEM BOTTOM VIEW**

*Figure 22. QuantEM:512SC Bottom View*

**Camera Weight**

Weight: 6.5 lbs. (2.8 kg)

## CCD Specifications and Orientation

<b>Window</b>		UV grade fused-silica Broadband MgF <sub>2</sub> anti-reflective coating on both surfaces
<b>CCD Array</b>		
	<b>CCD</b>	e2v CCD97-00
	<b>CCD Process</b>	Back Illuminated
	<b>Resolution</b>	512 x 512
	<b>Pixel Size</b>	16 μm x 16 μm
	<b>Readout Amplifiers (Ports)</b>	2
	<b>Digitalization (Readout) Rate</b>	10 MHz, 5 MHz, 1.25 MHz

**Table 3. CCD Specifications**

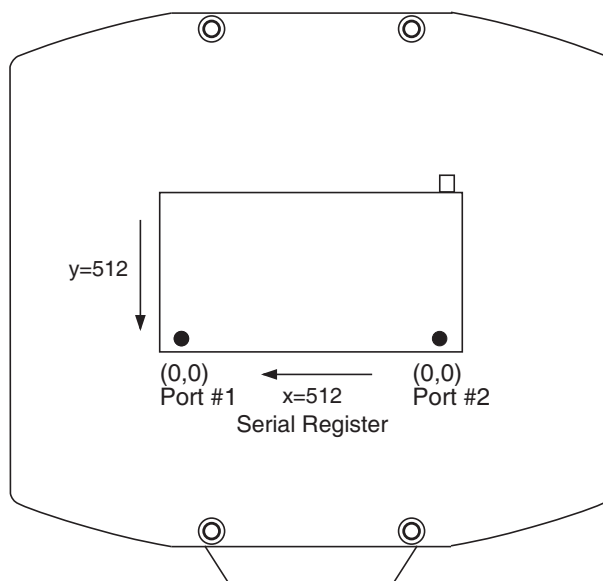

**Figure 23. QuantEM:512SC CCD Orientation**

# Connectors



**Figure 24. QuantEM:512SC Rear Panel**

The following connectors are located on the back of the camera.

-  *connector*: Type 1, 6 pin IEEE-1394a (FireWire).
- *POWER connector*: 5-pin, LEMO connector for camera power.
- *I/O connector*: Hirose HR10A-10R-10S, 10-pin connector for TTL level triggering functions and power indicator.

## Power Connector Pinout

1. +12V
2. +12V
3. GND
4. GND
5. GND

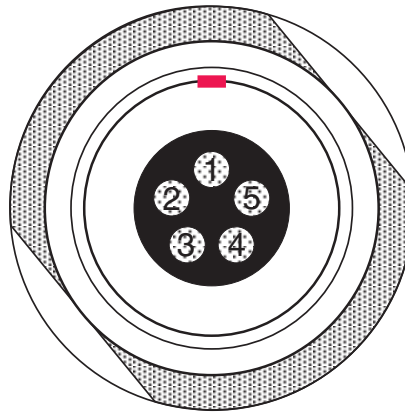
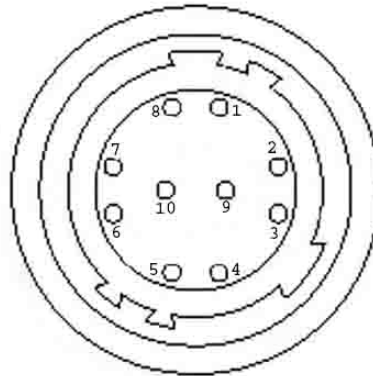

**Figure 25. Power Connector Pinout**

## I/O Connector Pinout

The I/O (Input/Output Status) connector provides information about trigger function, DAC, and TTL signals. Inputs must be at least 3.15 V for a high and less than 0.9 V for a low.

The numbers on the I/O connector diagram correspond to the numbers given to the definition of each of the pins. The I/O connector is a female, Hirose HR10A connector. An I/O cable (Part # 37-513-003) to access Trigger Input (Pin 1), Frame Readout (Pin 3), Camera exposing output (Pin 2), and Shutter Output (Pin 4) is available.



**Figure 26. Input/Output Connector**

INPUT/OUTPUT (I/O) TABLE		
#	I/O INPUT	DESCRIPTION
1	Trigger Input	This input is internally tied high through a 4.7kΩ resistor. A rising edge of the Trigger Input signal initiates the trigger. The trigger source would normally hold this input low and then drive it high to initiate the trigger.
2	Camera Exposing Output	Active high. A high level on this output indicates that the camera is exposing (integrating).
3	Frame Readout	Active high. A high level on this output indicates that data is being transferred.
4	Shutter Output	TTL output for timing of external shutter driver. Signal is high during Shutter Open Delay and exposure time. The pin does not provide power to drive the shutter directly, so an external shutter drive controller is required.
5	Spare Input	Reserved
6	Trigger Ready	This output notifies accessory devices that the camera is ready to receive a trigger.
7	TX Out	Accessory Serial Transmit
8	RX IN	Accessory Serial Receive
9	Power Status	A high level on this output indicates that the camera power is switched on (+5 V = on, 0 V = off).
10	GND	System digital ground. Any external circuitry intended to interface with the trigger control signals must reference this ground connection.

**Table 4. Input/Output Definitions**

# Power Supply Specifications and Dimensions

**Voltage Input:** 100-240 V~ @ 47-63 Hz

**Current Input:** 3.0 A

**Voltage Output:** +12 Vdc

**Maximum Power Output:** 96 W

**Power Supply Weight:** 2 lb (0.9 kg)

**Supply Cable Length:** 10 ft. / 3.048 m

---

**Note:** CE certification applies to the QuantEM:512SC *only* when the camera system is operated with a CE-approved power supply

---

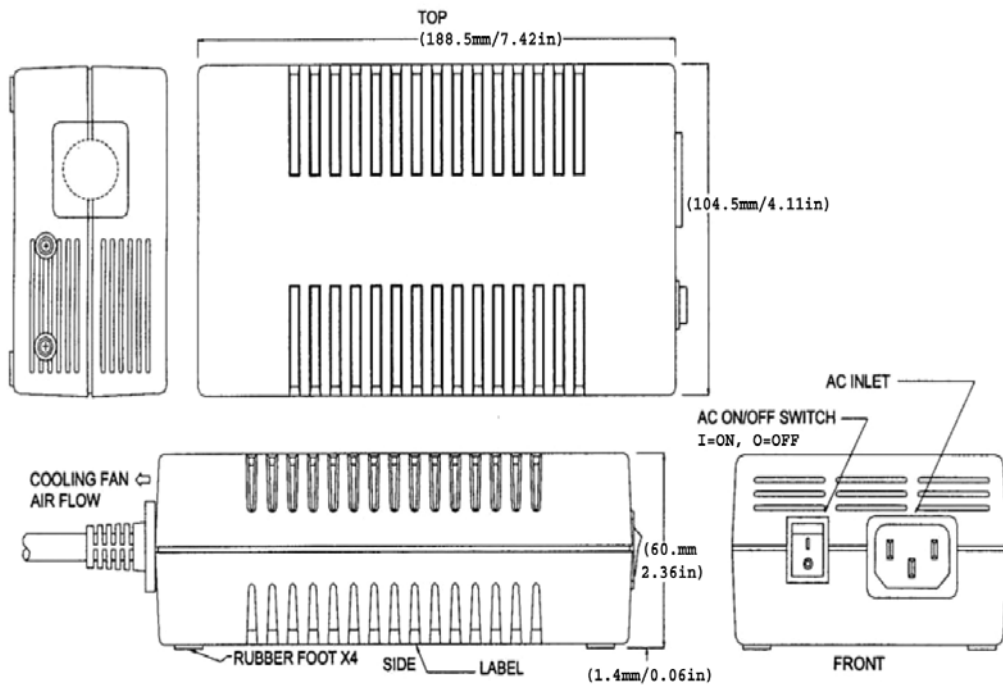

**Figure 27. Power Supply Front/Side & Top Views**

# Index

## **B**

Bias (Offset), 10  
Binning, 17, 21  
Bulb mode, 16

## **C**

Cleaning  
    exterior camera surfaces, 4  
    imaging window, 4  
C-mount, 8  
    adjusting, 8  
Computer (host), 6  
Conversion gain, 20  
Customer Service, ii

## **D**

Data connector, 7, 28  
Declaration of conformity  
    QuantEM:512SC, v  
Digitization speeds, 17

## **F**

FireWire, 3, 5, 7

## **I**

I/O connector, 7

## **L**

Lenses, 4

## **M**

Microscopes, 4  
Multiplication  
    gain, 1  
    port, 17  
    register, 1

## **N**

Non-overlap readout mode, 11

## **O**

On-chip multiplication gain, 10  
Overlap readout mode, 13

## **P**

Power connector, 7, 8, 28  
Power Supply, 4, 5, 8, 30  
Power switch, 7  
Precautions, 3  
PVCAM, 5, 6

## **Q**

QuantEM  
    512SC  
        Conversion gain, 17

## **R**

Readout modes  
    non-overlap, 11  
    overlap, 13  
Readout speed, 17  
Repairs, 4

## **S**

Saguaro software, 2, 5  
Software, iii, 5  
Specifications, 25  
Strobe mode, 16  
System components, 2

## **T**

Trigger modes  
    bulb, 16  
    strobe, 16  
    trigger-first, 15  
Trigger-first mode, 15  
Tripods, 4

## **W**

Warranty, iii  
    Your responsibility, iv

